



COMMERCIAL RESIN FURNITURE

Your best value for Food Service & Hospitality!

Versatile Resin Patio Fence

How Many Posts and How Many Sections of Panels Will I Need for my Grosfillex Enclosure?

**Use any combination of panel sections to go between the posts and bases to fit the measurements of your patio layout:*

- "On center" length
- Overall length, including end posts & bases

Post & Base

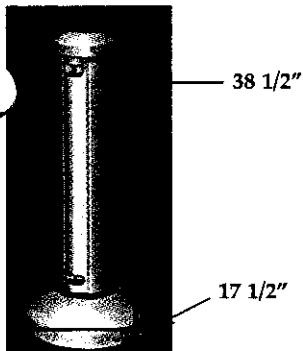

2 Panel Section

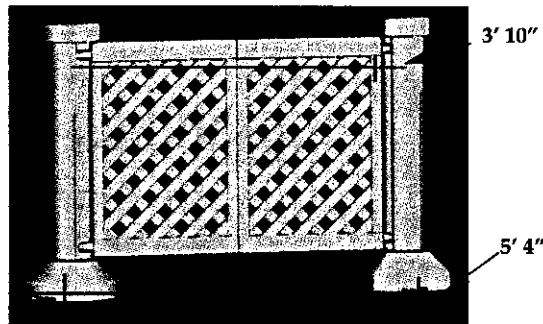

3 Panel Section

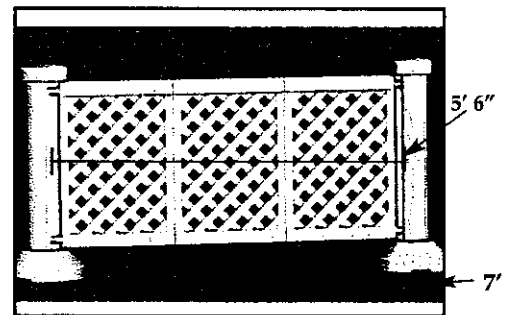

Number of Panels per Section

Length	2	3
"On Center" Length	3' 10"	5' 6"
Overall Length	5' 4"	7'

Design & Define your patio or terrace with this decorative, lattice panel fencing system that can be assembled and fitted to custom create our outdoor dining space! Each post and base can be filled with water or sand to 50 lbs. for extra stability. System can be easily moved and stored for ease of cleaning at the end of each season.

Please call your Grosfillex Representative for any further assistance • There may be other combinations that will fit your specific needs!

www.grosfillexfurniture.com • info@grosfillexfurniture.com
 PH (800) 233-3186 • FAX (610) 693-5414



*Use Chart Below as a Guideline to Calculate
How Many Panel Sections You Will
Need to Fit Selected Lengths
of Grosfillex® Enclosure*

"Nominal Length"	Number of Sections		"On Center Length"	Overall Length	Number of Posts & Bases
	2 Panels	3 Panels			
10 ft.	2		7' 8 1/2"	9' 2"	3
	1	1	9' 5"	10' 10"	3
15 ft.	4		15' 5"	16' 10 1/2"	5
20 ft.	5		19' 3"	20' 9"	6
	2	2	18' 9"	20' 3"	5
25 ft.	6		22' 1 1/2"	24' 7"	7
	3	2	22' 7 1/2"	24' 1"	6
		4	22' 1 1/2"	23' 7"	5
30 ft.		5	27' 8"	29' 2"	6
	3	3	28' 2"	29' 7 1/2"	7
	2	4	29' 10"	31' 3 1/2"	7
	6	1	28' 8"	30' 1 1/2"	8
35 ft.		6	33' 2"	34' 8"	7
	9		34' 8"	36' 2"	10
	6	2	34' 2"	35' 8"	9
	3	4	33' 8"	35' 2"	8
40 ft.		7	38' 1/2"	40' 2"	8
	10		38' 6 1/2"	40'	11
	3	5	39' 2 1/2"	40' 8"	9
	9	1	40' 2 1/2"	41' 8"	11
	4	4	37' 6 1/2"	39'	9
	7	2	38' 1/2"	39' 6"	10

Note: Number of posts and bases needed for a line of sections = Total # of sections +1!!

Number of posts and bases needed for a combination of sections in a geometric space, (i.e., a rectangle) without any access through the fence: Total # of Sections +1!

Number of posts and bases needed for a combination of sections in a geometric space with access through the fence: Total # of Sections +1 + # of accesses (entry ways through fence).

Please call your Grosfillex Representative for any further assistance - as there may be other combinations that will fit your specific needs!

www.grosfillexfurniture.com • info@grosfillexfurniture.com

PH (800) 233-3186 • FAX (610) 693-5414



COMMERCIAL RESIN FURNITURE

Your best value for Food Service & Hospitality!

Assembly Instructions for Decorative Patio Fence

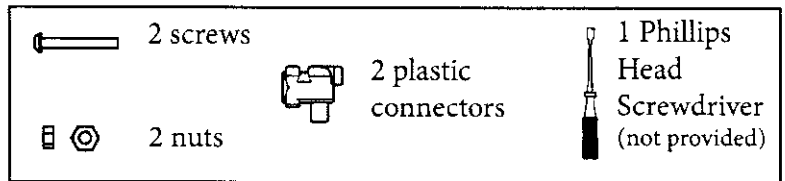

1 Using a funnel, fill each post and base with water, sand, or any other granular material as needed.



2 Insert each post into a base and rotate 90 degrees into locking position.



3 Assemble male and female aluminum tubes. Make sure they are inserted all the way and locked together using the groove and small punched guide on the matching tubes. Check that the screw holes at both ends of the tube assembly are in the same direction.

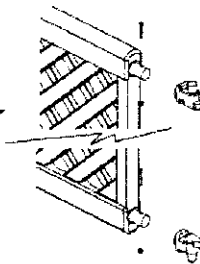

4 Insert and slide aluminum tubes through top and bottom holes of panels. Center panel assembly onto tubes. Screw holes should face up.



5 Assemble the plastic connectors provided to the end of top and bottom tubes using the screws and nuts provided. Make sure that connector pegs are facing up for the upper tube and down for the lower tube on both ends of the panel/tube assembly.

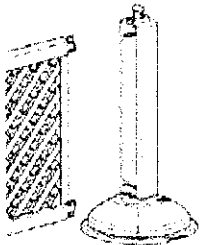

6 Insert bottom plastic pegs of connectors into the holes of the bases and position top plastic connectors into posts. **DO NOT ASSEMBLE MORE THAN 3 PANELS BETWEEN 2 POSTS.** For another straight section of fence, repeat steps 3-6 as needed



7 For right angle fence assembly, rotate the corner post 45 degrees before installing the next section of paneling.

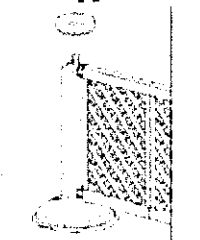

8 Insert post caps onto posts and rotate 90 degrees into locking position.



9 Slide fence into desired location.

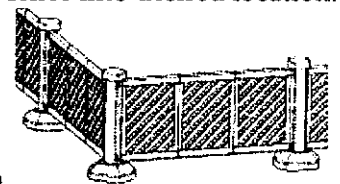

Note: For anchored post installation, drill 1/4" holes through anchor bolt holes in the base to further secure fence assembly in position (wedge anchors and J bolts are not included).

www.grosfillexfurniture.com • info@grosfillexfurniture.com